

负温度系数热敏电阻器：SCH 系列



高功率型热敏电阻器

■ 特点

1. 满足RoHS和无卤的要求
2. 本体尺寸：Φ20,Φ25,Φ30mm
3. 径向引线树脂封装
4. 更高的稳态电流
5. 与同类元件相比，节省50%的安装空间



■ 用途

1. 各种大功率开关电源、UPS电源、转换电源
2. 电动汽车充电器、充电桩
3. 电机驱动装置、大功率等离子体焊接机、切割机、大功率照明工具
4. 核磁共振设备、大功率专业音频功放机、大功率环形变压器、大容量大功率逆变器
5. 高压电源驱动的工业机器人、低压智能电柜

■ 编码规则

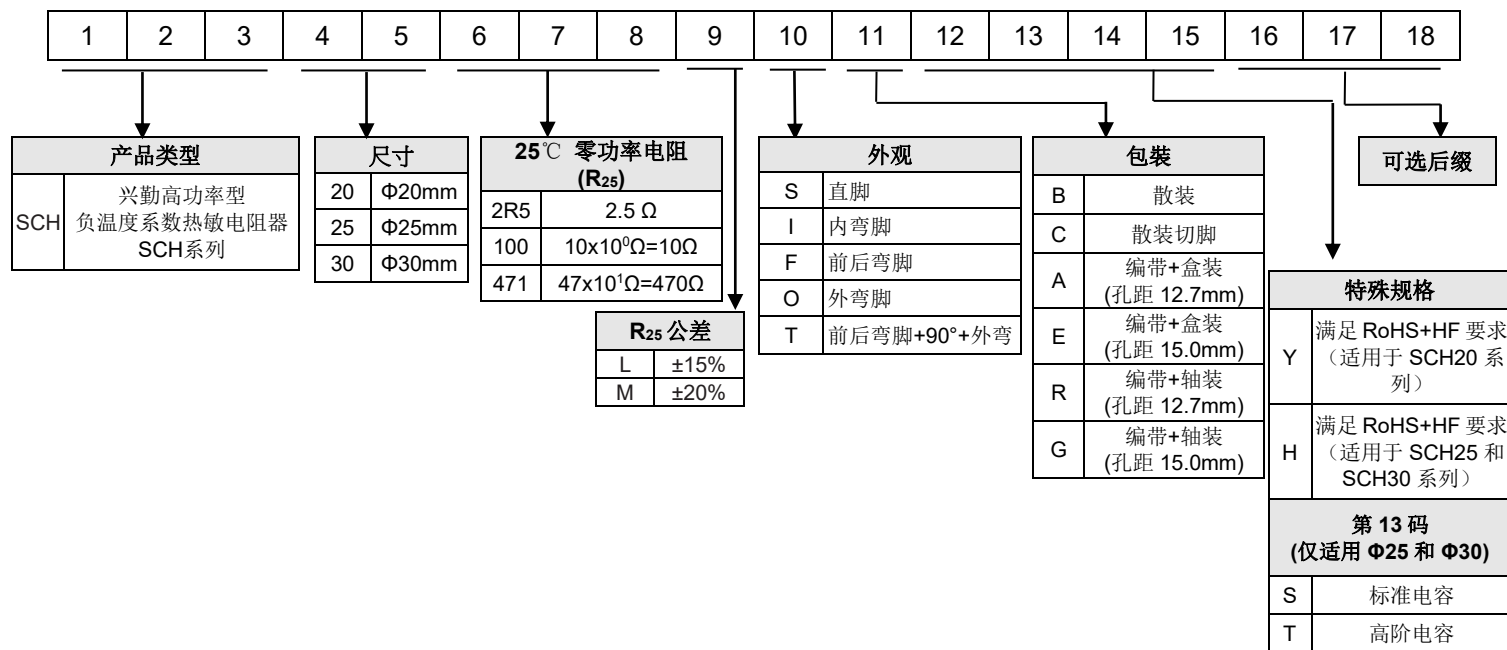

负温度系数热敏电阻器：SCH 系列



高功率型热敏电阻器

■ 结构与尺寸

S 型 (直脚)

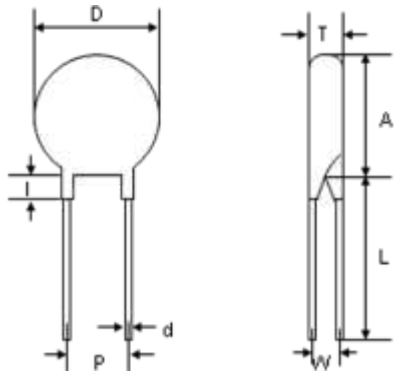

(单位：mm)

本体尺寸	Dmax.	P	d	l max.	A max.	L min.	T	W
Φ20	18~21.5	7.5±0.5	1.0±0.02	3	21.5	26	3.5~6.0	3.1±0.5
Φ25-S	23~29	7.5±1	1.0±0.02	3	29	22	5±1	3.3±0.5
Φ25-T	23~29	7.5±1	1.0±0.02	3	29	22	6±1	3.6±0.5
Φ30-S	30~36	7.5±1	1.0±0.02	3	36	22	5±1	3.3±0.5
Φ30-T	30~36	7.5±1	1.0±0.02	3	36	22	6±1	3.6±0.5

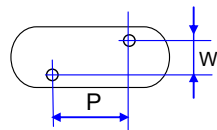

P:引线圆心水平投影距离

SC 型 (直脚切脚型)

(单位：mm)

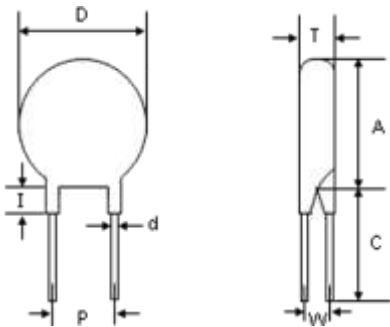

本体尺寸	Dmax.	P	d	l max.	A max.	C nor.	T	W
Φ20	18~21.5	7.5±0.5	1.0±0.02	3	21.5	□±1	3.5~6.0	3.1±0.5
Φ25-S	23~29	7.5±1	1.0±0.02	3	29	□±1	5±1	3.3±0.5
Φ25-T	23~29	7.5±1	1.0±0.02	3	29	□±1	6±1	3.6±0.5
Φ30-S	30~36	7.5±1	1.0±0.02	3	36	□±1	5±1	3.3±0.5
Φ30-T	30~36	7.5±1	1.0±0.02	3	36	□±1	6±1	3.6±0.5

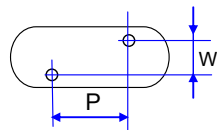

P:引线圆心水平投影距离

C nor.的□: 长度依据客户要求

I 型 (内弯脚型)

(单位：mm)

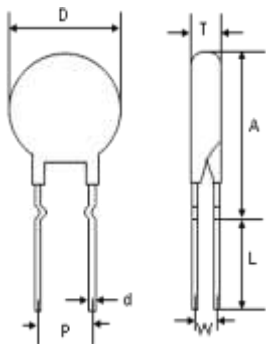

本体尺寸	Dmax.	P	d	A max.	L min.	T	W
Φ20	18.0~21.5	7.5±0.5	1±0.02	28	24	3.5~6.0	3.1±0.5
Φ25-S	23~29	7.5±1	1±0.02	35	22	5±1	3.3±0.5
Φ25-T	23~29	7.5±1	1±0.02	35	22	6±1	3.6±0.5
Φ30-S	30~36	7.5±1	1±0.02	42	22	5±1	3.3±0.5
Φ30-T	30~36	7.5±1	1±0.02	42	22	6±1	3.6±0.5

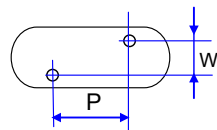

P:引线圆心水平投影距离

IC 型 (内弯脚切脚型)

(单位：mm)

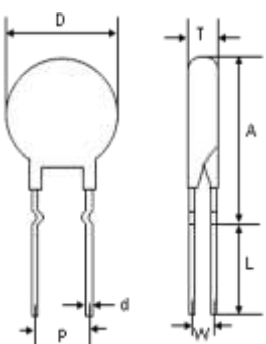

本体尺寸	Dmax.	P	d	A max.	C nor.	T	W
Φ20	18.0~21.5	7.5±0.5	1±0.02	28	□±1	3.5~6.0	3.1±0.5
Φ25-S	23~29	7.5±1	1±0.02	35	□±1	5±1	3.3±0.5
Φ25-T	23~29	7.5±1	1±0.02	35	□±1	6±1	3.6±0.5
Φ30-S	30~36	7.5±1	1±0.02	42	□±1	5±1	3.3±0.5
Φ30-T	30~36	7.5±1	1±0.02	42	□±1	6±1	3.6±0.5

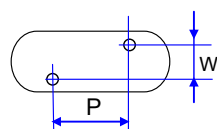

P:引线圆心水平投影距离

C nor.的□: 长度依据客户要求

负温度系数热敏电阻器：SCH 系列



高功率型热敏电阻器

O 型 (外弯脚型)

(单位：mm)

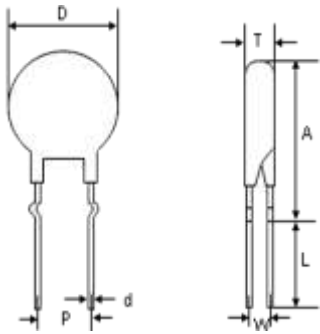

本体尺寸	Dmax.	P	d	A max.	L min.	T	W
Φ20	18~21.5	7.5±0.5	1±0.02	30	24	3.5~6	3.1±0.5
Φ25-S	23~29	7.5±1	1±0.02	35	22	5±1	3.3±0.5
Φ25-T	23~29	7.5±1	1±0.02	35	22	6±1	3.6±0.5
Φ30-S	30~36	7.5±1	1±0.02	42	22	5±1	3.3±0.5
Φ30-T	30~36	7.5±1	1±0.02	42	22	6±1	3.6±0.5

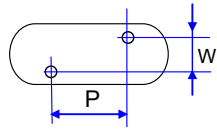

P:引线圆心水平投影距离

(单位：mm)

OC 型 (外弯脚切脚型)

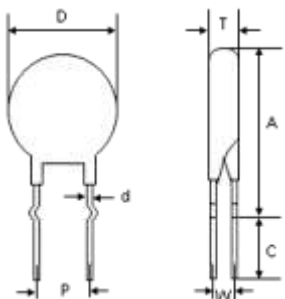

本体尺寸	Dmax.	P	d	A max.	C nor.	T	W
Φ20	18~21.5	7.5±0.5	1±0.02	30	□±1	3.5~6	3.1±0.5
Φ25-S	23~29	7.5±1	1±0.02	35	□±1	5±1	3.3±0.5
Φ25-T	23~29	7.5±1	1±0.02	35	□±1	6±1	3.6±0.5
Φ30-S	30~36	7.5±1	1±0.02	42	□±1	5±1	3.3±0.5
Φ30-T	30~36	7.5±1	1±0.02	42	□±1	6±1	3.6±0.5

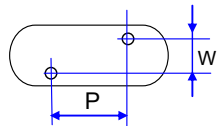

P:引线圆心水平投影距离

C nor.的□: 长度依据客户要求

F 型 (前后弯脚型)

(单位：mm)

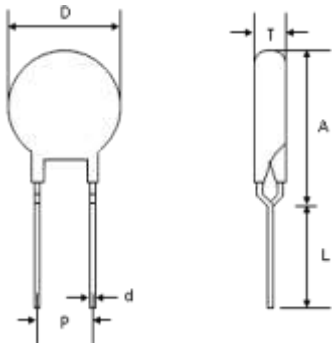

本体尺寸	Dmax.	P	d	A max.	L min.	T
Φ20	18.0~21.5	7.5±0.5	1±0.02	24.5	25	3.5~6.0
Φ25-S	23~29	7.5±1	1±0.02	35	22	5±1
Φ25-T	23~29	7.5±1	1±0.02	35	22	6±1
Φ30-S	30~36	7.5±1	1±0.02	42	22	5±1
Φ30-T	30~36	7.5±1	1±0.02	42	22	6±1

FC 型 (前后弯脚切脚型)

(单位：mm)

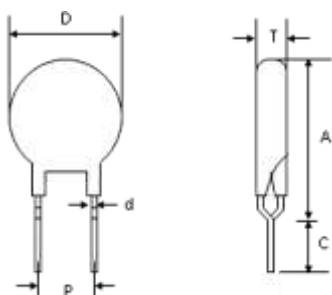

本体尺寸	Dmax.	P	d	A max.	C nor.	T
Φ20	18.0~21.5	7.5±0.5	1±0.02	24.5	□±1	3.5~6.0
Φ25-S	23~29	7.5±1	1±0.02	35	□±1	5±1
Φ25-T	23~29	7.5±1	1±0.02	35	□±1	6±1
Φ30-S	30~36	7.5±1	1±0.02	42	□±1	5±1
Φ30-T	30~36	7.5±1	1±0.02	42	□±1	6±1

C nor.的□: 长度依据客户要求

负温度系数热敏电阻器：SCH 系列

高功率型热敏电阻器



T 型 (前后弯脚+90°弯折+外弯)

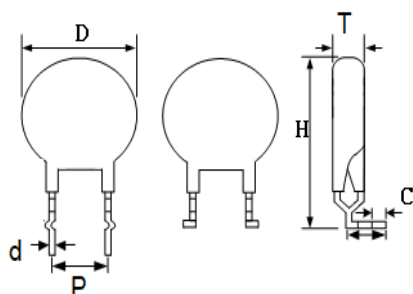

(单位：mm)

本体尺寸	Dmax.	P	d	T	H max.	C
Φ20	18.0~21.5	7.5±0.5	1.0±0.02	3.5~6.0	26	□±0.5

C nor.的□: 长度依据客户要求

T 型 (前后弯脚+90°弯折)

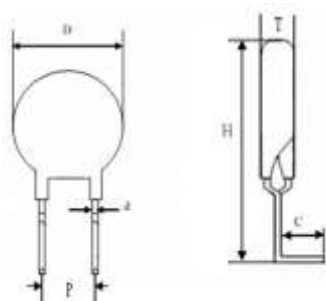

(单位：mm)

本体尺寸	Dmax.	P	d	Hmax	C nor.	T
Φ20	18.0~21.5	7.5±0.5	1.0±0.02	28.5	□±0.5	3.5~6.0

C nor.的□: 长度依据客户要求

■ 打印标识

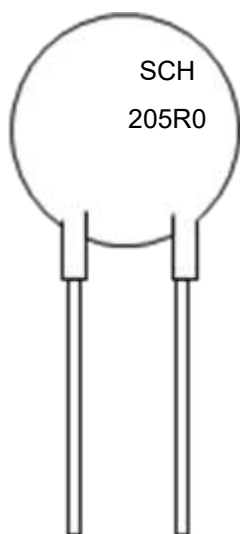

→ 产品别

→ 第一、二码为尺寸别

第三至第五码为型号别

负温度系数热敏电阻器：SCH 系列



高功率型热敏电阻器

■ 电气特性

SCH20 系列

型号	零功率电阻 @25°C		最大 稳态电流 @65°C	最大稳态 电流下的 残余电阻 @25°C	B 值 (25/50)		建议电容值 @240Vac	最大 额定功率 @25°C	耗散系数	热时 常数																																																		
	R ₂₅ (Ω)	(±%)	I _{max} (A)	R _{lmax} (Ω)	(K)	(±%)	(μF)	P _{max} (W)	δ (mW/°C)	τ (Sec.)																																																		
SCH200R7	0.7	15	18	0.018	2300	7	1200	5.8	约 28	约 113																																																		
		20																																																										
SCH201R0	1	15	16	0.023	2500						7	1200	5.9	约 28	约 113																																													
		20																																																										
SCH201R5	1.5	15	13	0.035	2600											7	1200	5.9	约 28	约 113																																								
		20																																																										
SCH202R0	2	15	12	0.042	2750																7	1200	6.0	约 28	约 113																																			
		20																																																										
SCH202R5	2.5	15	11	0.050	2750																					7	1200	6.1	约 28	约 113																														
		20																																																										
SCH203R0	3	15	11	0.052	2800																										7	1200	6.3	约 28	约 113																									
		20																																																										
SCH204R0	4	15	9.5	0.067	3000																															7	1200	6.0	约 28	约 113																				
		20																																																										
SCH204R7	4.7	15	9.5	0.074	3000																																				7	1200	6.7	约 28	约 113															
		20																																																										
SCH205R0	5	15	9.5	0.076	3000																																									7	1200	6.9	约 28	约 113										
		20																																																										
SCH206R0	6	15	9	0.083	3050																																														7	1200	6.7	约 28	约 113					
		20																																																										
SCH206R8	6.8	15	8.5	0.093	3100																																																			7	1200	6.7	约 28	约 113
		20																																																										
SCH207R0	7	15	8.5	0.095	3100	7	1200	6.9	约 28	约 113																																																		
		20																																																										
SCH208R0	8	15	8	0.101	3150						7	1200	6.5	约 28	约 113																																													
		20																																																										
SCH20100	10	15	7.5	0.126	3200											7	1200	7.1	约 28	约 113																																								
		20																																																										
SCH20120	12	15	7.5	0.123	3200																7	1200	6.9	约 28	约 113																																			
		20																																																										
SCH20130	13	15	7.5	0.125	3250																					7	1200	7.0	约 28	约 113																														
		20																																																										
SCH20150	15	15	7	0.145	3250																										7	1200	7.1	约 28	约 113																									
		20																																																										
SCH20160	16	15	6.5	0.158	3300																															7	1200	6.7	约 28	约 113																				
		20																																																										
SCH20180	18	15	6	0.159	3350																																				7	1200	5.7	约 28	约 113															
		20																																																										
SCH20200	20	15	6	0.185	3350																																									7	1200	6.7	约 28	约 113										
		20																																																										
SCH20470	47	15	4.5	0.336	3550																																														7	1200	6.8	约 28	约 113					
		20																																																										
SCH20550	55	15	4	0.409	3550																																																			7	1200	6.5	约 28	约 113
		20																																																										
SCH20121	120	15	3	0.697	3550	7	1200	6.3	约 28	约 113																																																		
		20																																																										

负温度系数热敏电阻器：SCH 系列



高功率型热敏电阻器

■ 电气特性

SCH25-S/ T系列

型号	零功率电阻 @25°C		最大 稳态电流 @25°C	最大稳态 电流下的 残余电阻 @25°C	B 值 (25/50)		建议电容值 @240Vac	最大 额定功率 @25°C	耗散系数	热时 常数
	R ₂₅ (Ω)	(±%)	I _{max} (A)	R _{imax} (Ω)	(K)	(±%)	(μF)	P _{max} (W)	δ (mW/°C)	τ (Sec.)
SCH251R0	1	15	22.5	0.019	2600	7	S: 2200 T: 4200	9.6	约 30	约 130
		20								
SCH251R5	1.5	15	21.5	0.022	2600					
		20								
SCH252R0	2	15	21	0.024	2800					
		20								
SCH252R5	2.5	15	19.5	0.027	2800					
		20								
SCH253R0	3	15	18	0.030	2900					
		20								
SCH254R0	4	15	17	0.035	3000					
		20								
SCH254R7	4.7	15	16.5	0.037	3100					
		20								
SCH255R0	5	15	16	0.040	3100					
		20								
SCH256R8	6.8	15	14.5	0.054	3150					
		20								
SCH257R0	7	15	14	0.055	3150					
		20								
SCH258R0	8	15	13	0.060	3200					
		20								
SCH25100	10	15	12	0.063	3300					
		20								
SCH25120	12	15	11	0.066	3300					
		20								
SCH25150	15	15	9	0.108	3350					
		20								
SCH25180	18	15	8.5	0.115	3450					
		20								
SCH25200	20	15	8	0.139	3500					
		20								
SCH25121	120	15	5	0.377	4000					
		20								

负温度系数热敏电阻器：SCH 系列



高功率型热敏电阻器

■ 电气特性

SCH30-S/ T系列

型号	零功率电阻 @25°C		最大 稳态电流 @25°C	最大稳态 电流下的 残余电阻 @25°C	B 值 (25/50)		建议电容值 @240Vac	最大 额定功率 @25°C	耗散系数	热时 常数
	R ₂₅ (Ω)	(±%)	I _{max} (A)	R _{imax} (Ω)	(K)	(±%)	(μF)	P _{max} (W)	δ (mW/°C)	τ (Sec.)
SCH300R5	0.5	15	38	0.010	2600	7	S: 3000 T: 5200	14.4	约 40	约 190
		20								
SCH301R0	1	15	34	0.012	2600					
		20								
SCH301R5	1.5	15	30	0.014	2600					
		20								
SCH302R0	2	15	27	0.017	2800					
		20								
SCH302R5	2.5	15	24	0.021	2800					
		20								
SCH303R0	3	15	24	0.023	3000					
		20								
SCH304R0	4	15	21	0.029	3000					
		20								
SCH304R7	4.7	15	20	0.032	3100					
		20								
SCH305R0	5	15	19.5	0.033	3150					
		20								
SCH306R0	6	15	18	0.037	3200					
		20								
SCH306R8	6.8	15	17	0.040	3250					
		20								
SCH307R0	7	15	17	0.041	3250					
		20								
SCH308R0	8	15	16.5	0.045	3250					
		20								
SCH30100	10	15	16	0.052	3300					
		20								
SCH30120	12	15	14	0.064	3450					
		20								
SCH30150	15	15	14	0.073	3500					
		20								
SCH30180	18	15	12	0.092	3500					
		20								
SCH30200	20	15	10	0.104	3550					
		20								

负温度系数热敏电阻器: SCH 系列



高功率型热敏电阻器

最大功耗减额曲线

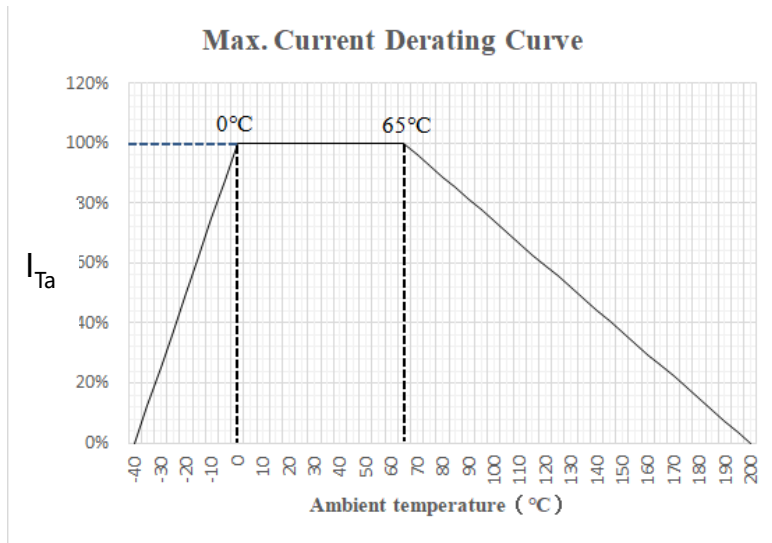

T_U : 工作温度上限(°C)

T_L : 工作温度下限(°C)

例如:

环境温度(T_a) = 85°C

工作温度上限(T_U) = 200°C

$$I_{Ta} = [1 - (T_a - 65) / (T_U - 65)] \times I_{max} = 85.2\% I_{max}$$

环境温度(T_a) = -10°C

工作温度下限(T_L) = -40°C

$$I_{Ta} = (1 - T_a / T_L) \times I_{max} = 75\% I_{max}$$

电阻-温度特性曲线

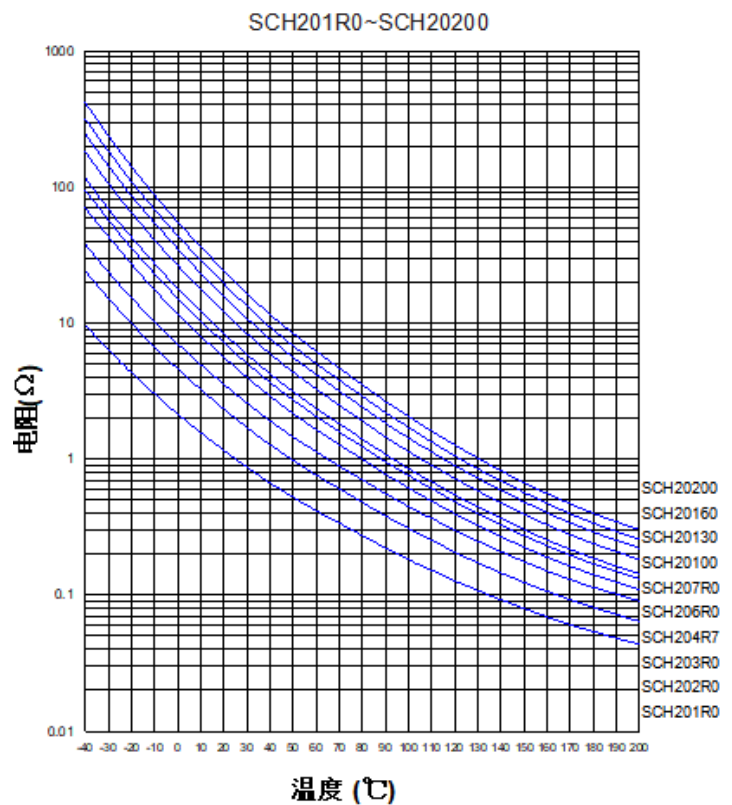
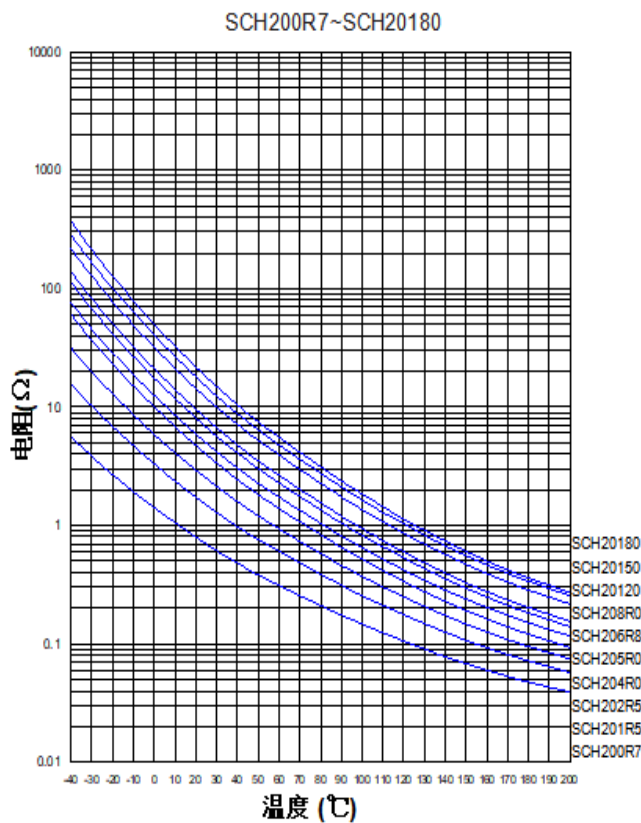

负温度系数热敏电阻器: SCH 系列



高功率型热敏电阻器

■ 电阻-温度特性曲线

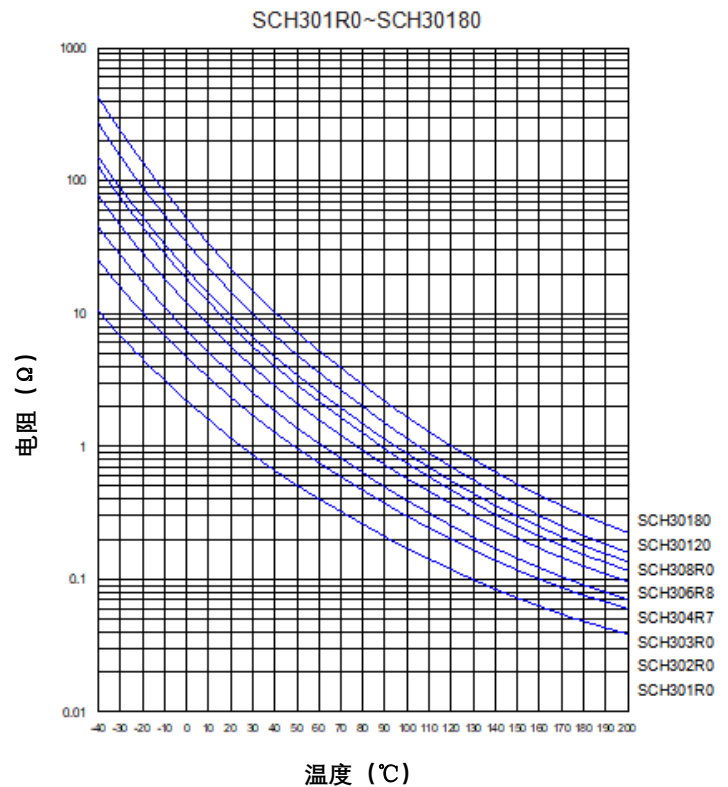
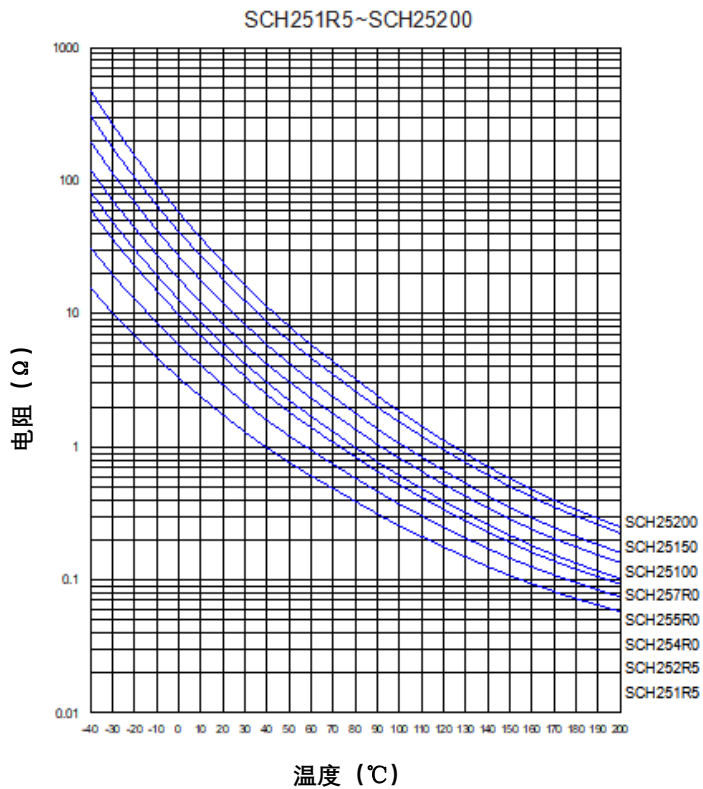
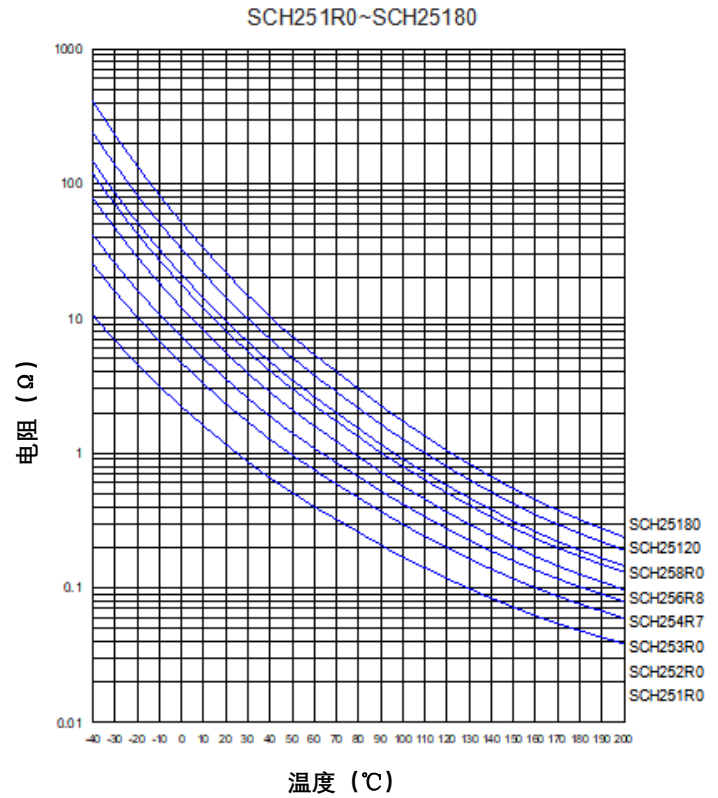
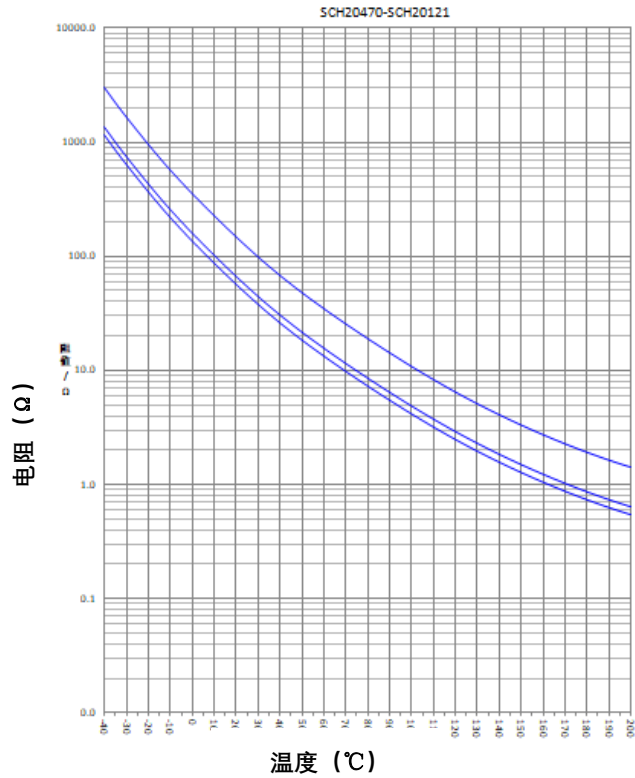

负温度系数热敏电阻器: SCH 系列



高功率型热敏电阻器

■ 电压-电流特性曲线 (代表性曲线)

SCH20 电压-电流特性曲线图(代表线)

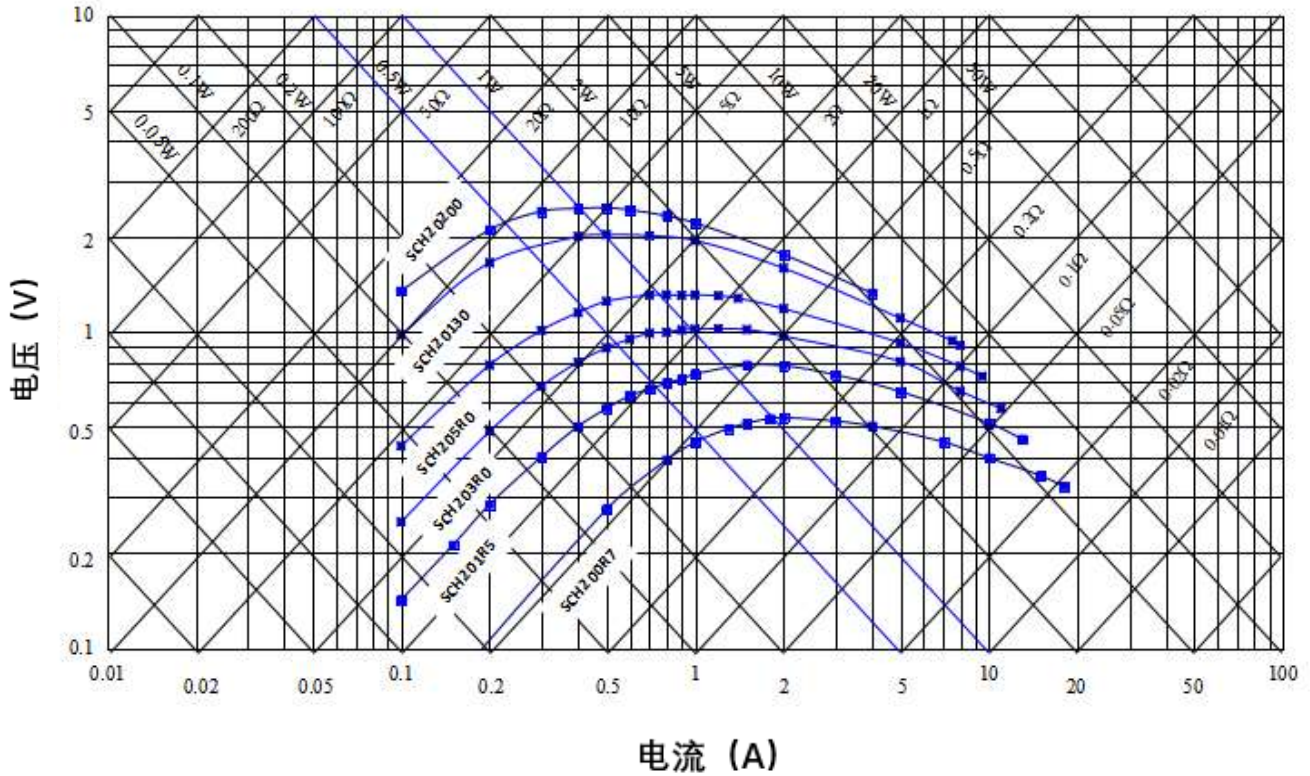

SCH25 电压-电流特性曲线图(代表线)

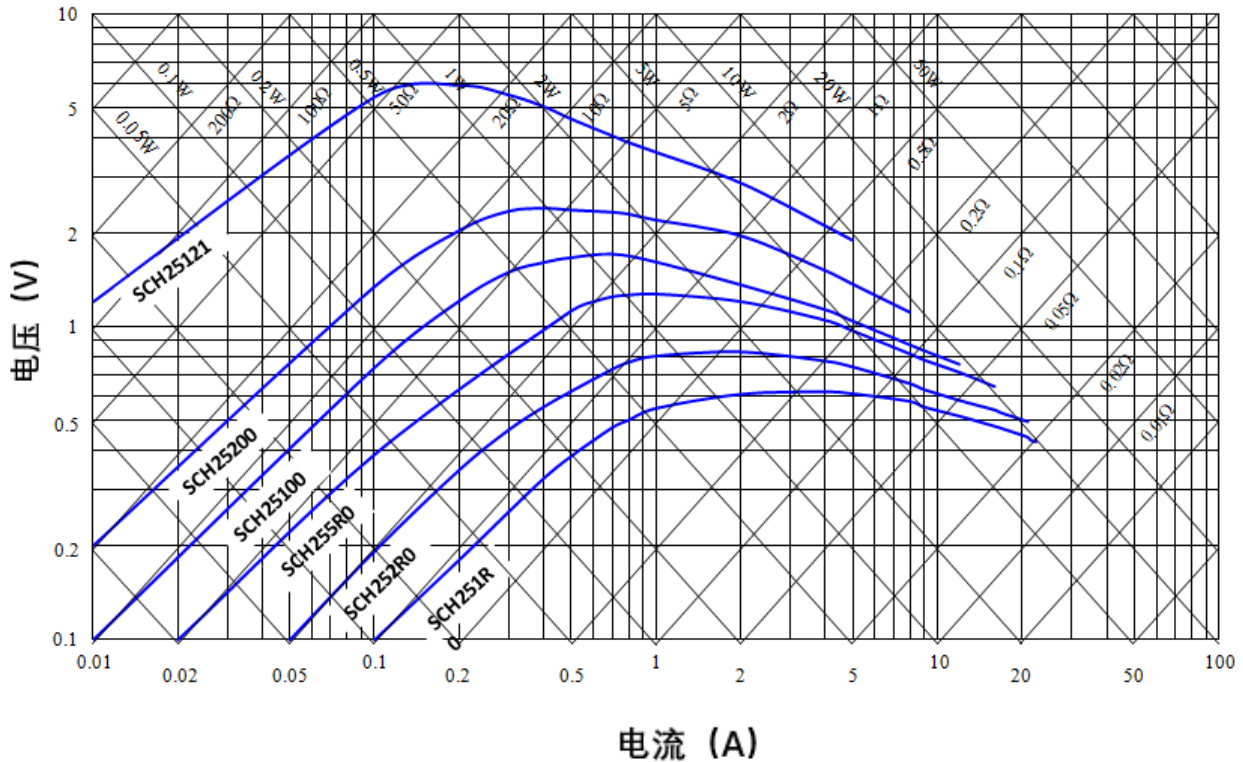

负温度系数热敏电阻器：SCH 系列



高功率型热敏电阻器

■ 电压-电流特性曲线（代表性曲线）

SCH30 电压-电流特性曲线图(代表线)

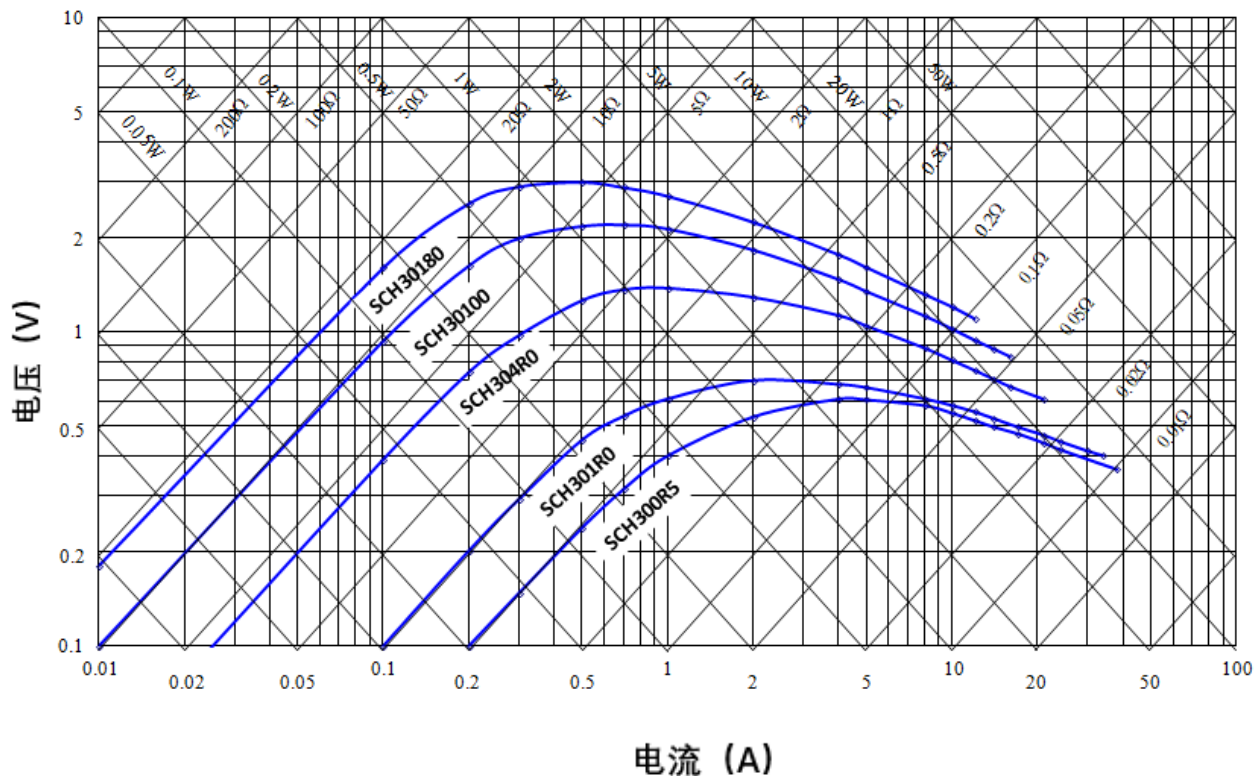

负温度系数热敏电阻器：SCH 系列



高功率型热敏电阻器

■ 推荐焊接条件

● 波峰焊曲线

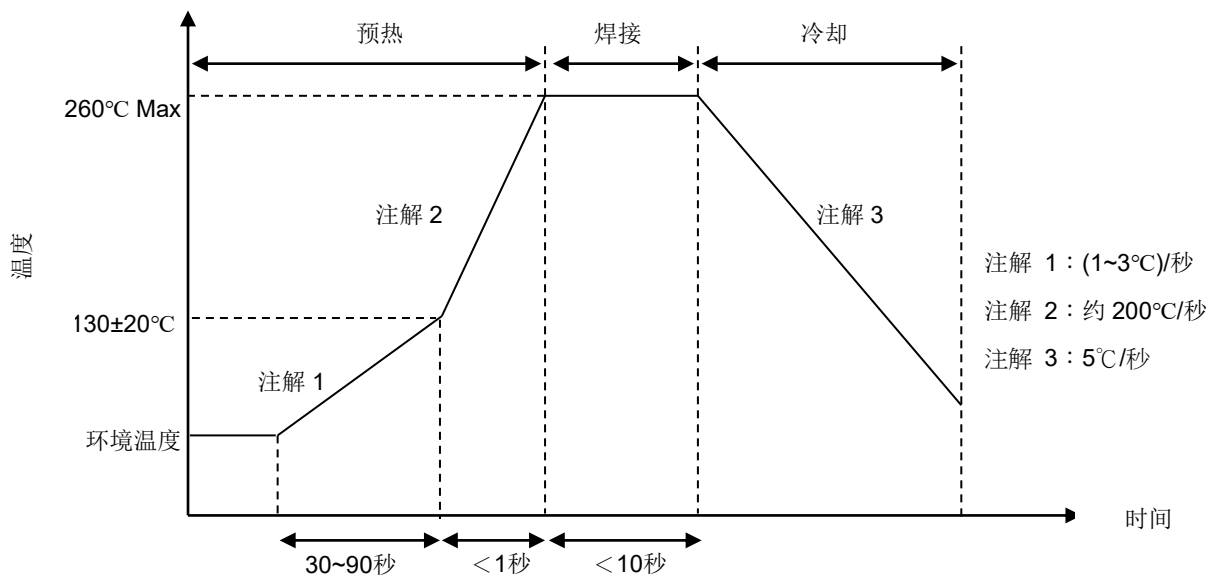

● 建议重工烙铁条件

项目	条件
烙铁头部温度	360°C (max.)
焊接时间	3 sec. (max.)
焊接位置与涂装层距离	2 mm (min.)

负温度系数热敏电阻器：SCH 系列



高功率型热敏电阻器

■ 可靠性

试验项目	测试标准	试验条件 / 方法	性能要求															
引出端强度	IEC 60068-2-21	2kg, 10±2 sec	无外观损伤															
抗弯曲强度	IEC 60068-2-21	1kg, 90°, 2次	无外观损伤															
可焊性	IEC 60068-2-20	245 ± 3°C, 3 ± 0.3 秒	着锡面积 ≥ 95%															
耐焊接热	IEC 60068-2-20	260 ± 3°C, 10 ± 1 秒(浸渍法)	无外观损伤 ΔR ₂₅ /R ₂₅ ≤ 10 %															
高温储存	IEC 60068-2-2	T _u ± 5 °C, 1000 ± 24 小时	无外观损伤 ΔR ₂₅ /R ₂₅ ≤ 20 %															
稳态湿热	IEC 60068-2-78	40 ± 2°C, 90~95% RH, 1000 ± 24 小时	无外观损伤 ΔR ₂₅ /R ₂₅ ≤ 20 %															
温度快速变化	IEC 60068-2-14	<p>温度急变按下表条件循环 5 个周期。</p> <table border="1"> <thead> <tr> <th>步骤</th> <th>温度 (°C)</th> <th>周期 (分钟)</th> </tr> </thead> <tbody> <tr> <td>1</td> <td>T_L ± 5</td> <td>30 ± 3</td> </tr> <tr> <td>2</td> <td>室温</td> <td>5 ± 3</td> </tr> <tr> <td>3</td> <td>T_U ± 5</td> <td>30 ± 3</td> </tr> <tr> <td>4</td> <td>室温</td> <td>5 ± 3</td> </tr> </tbody> </table>	步骤	温度 (°C)	周期 (分钟)	1	T _L ± 5	30 ± 3	2	室温	5 ± 3	3	T _U ± 5	30 ± 3	4	室温	5 ± 3	无外观损伤 ΔR ₂₅ /R ₂₅ ≤ 20 %
步骤	温度 (°C)	周期 (分钟)																
1	T _L ± 5	30 ± 3																
2	室温	5 ± 3																
3	T _U ± 5	30 ± 3																
4	室温	5 ± 3																
最大电流 (I _{max})	IEC 60539-1 4.26.1	25 ± 5°C, I _{max} ., 1000± 24 小时	无外观损伤 ΔR ₂₅ /R ₂₅ ≤ 20 %															
耐久性 (OnOff)	IEC60539-1 5.25.6	25 ± 5°C, I _{max} ., C _{th} , 1 分钟 通 / 5 分钟 断 x 1000 周期 C _{th} = 240 Vac下的建议电容值	无外观损伤 ΔR ₂₅ /R ₂₅ ≤ 20 %															
绝缘测试	MIL-STD-202F -Method 302	1000 V _{DC} , 1分钟	≥ 500 MΩ															

负温度系数热敏电阻器：SCH 系列



高功率型热敏电阻器

■ 包装方式

● 编带包装方式

S 型(直脚)

图 A



图 B



(单位: mm)

编带尺寸	本体尺寸	P0	F	P	P1	H	H1	d	W0	W1	W2	W	ΔP	Δh	L1	D0	T	图形
		±0.3	±0.5	±1	±0.7	+2/-0	Max.	±0.02	±1.5	+0.75 /-0.5	Max.	+1/ -0.5	Max.	Max.	Min	±0.2	±0.2	
P0:12.7	20	12.7	7.5	25.4	8.95	18	42	1.0	12	9	3	18	1	2	9	4	0.6	A
	20	12.7	10	25.4	7.70	18	42	1.0	12	9	3	18	1	2	9	4	0.6	A
P0:15.0	20	15.0	7.5	30	3.75	18	42	1.0	12	9	3	18	1	2	9	4	0.6	B
	20	15.0	10	30	10.0	18	42	1.0	12	9	3	18	1	2	9	4	0.6	A

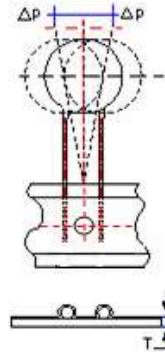
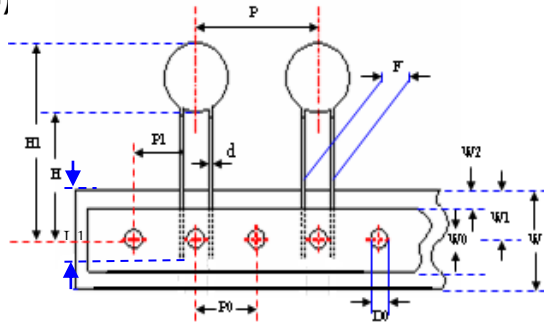
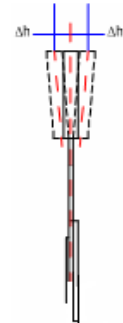
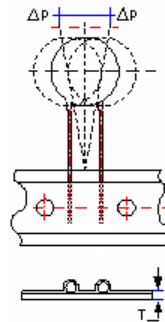
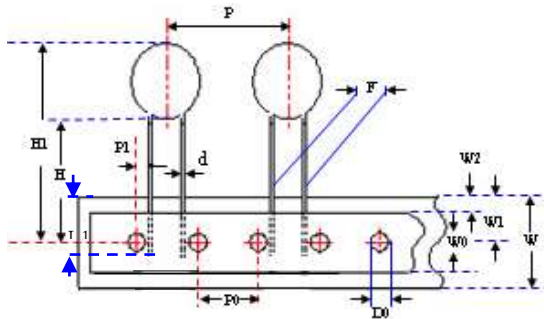
I 型(内弯脚)

图 A

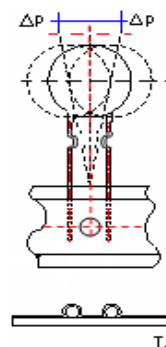
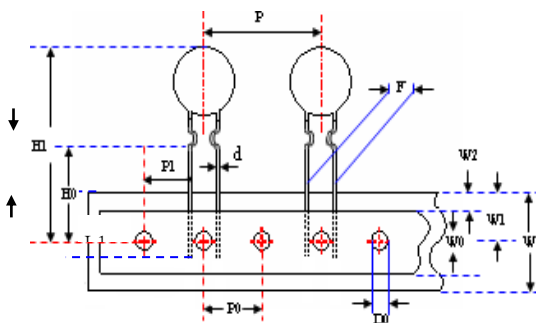

负温度系数热敏电阻器：SCH 系列

高功率型热敏电阻器



图 B

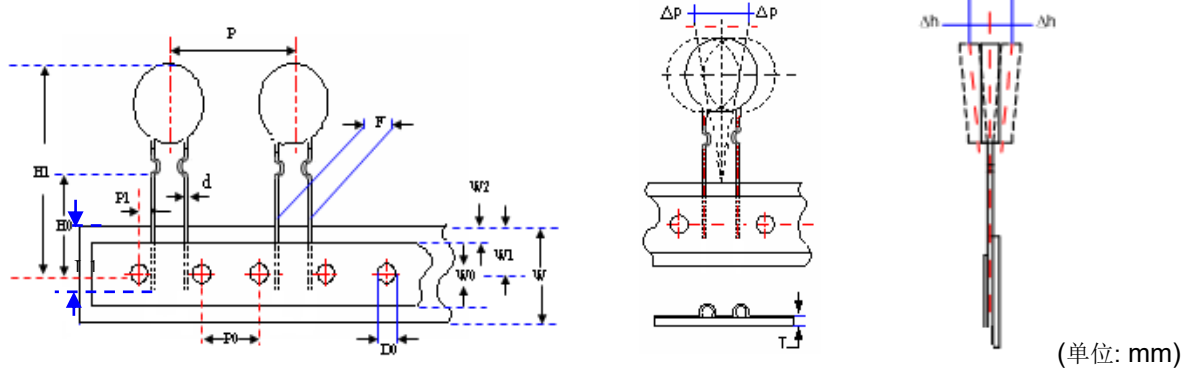

(单位: mm)

编带尺寸	本体尺寸	P0	F	P	P1	H	H1	d	W0	W1	W2	W	ΔP	Δh	L1	D0	T	图形
		±0.3	±0.5	±1	±0.7	+2/-0	Max.	±0.02	±1.5	+0.75 /-0.5	Max.	+1/ -0.5	Max.	Max.	Min	±0.2	±0.2	
P0:12.7	20	12.7	7.5	25.4	8.95	16	44	1.0	12	9	3	18	1	2	9	4	0.6	A
	20	12.7	10	25.4	7.70	16	44	1.0	12	9	3	18	1	2	9	4	0.6	A
P0:15.0	20	15.0	7.5	30	3.75	16	44	1.0	12	9	3	18	1	2	9	4	0.6	B
	20	15.0	10	30	10	16	44	1.0	12	9	3	18	1	2	9	4	0.6	A

○型(外弯脚)

图 A



图 B



(单位: mm)

编带尺寸	本体尺寸	P0	F	P	P1	H	H1	d	W0	W1	W2	W	ΔP	Δh	L1	D0	T	图形
		±0.3	±0.5	±1	±0.7	+2/-0	Max.	±0.02	±1.5	+0.75 /-0.5	Max.	+1/ -0.5	Max.	Max.	Min	±0.2	±0.2	
P0:12.7	20	12.7	7.5	25.4	8.95	16	46	1.0	12	9	3	18	1	2	9	4	0.6	A
	20	12.7	10	25.4	7.7	16	44	1.0	12	9	3	18	1	2	9	4	0.6	A
P0:15.0	20	15.0	7.5	30	3.75	16	46	1.0	12	9	3	18	1	2	9	4	0.6	B
	20	15.0	10	30	10	16	44	1.0	12	9	3	18	1	2	9	4	0.6	A

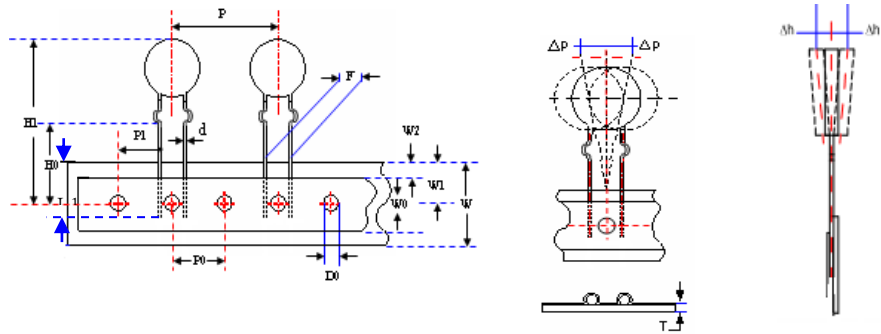
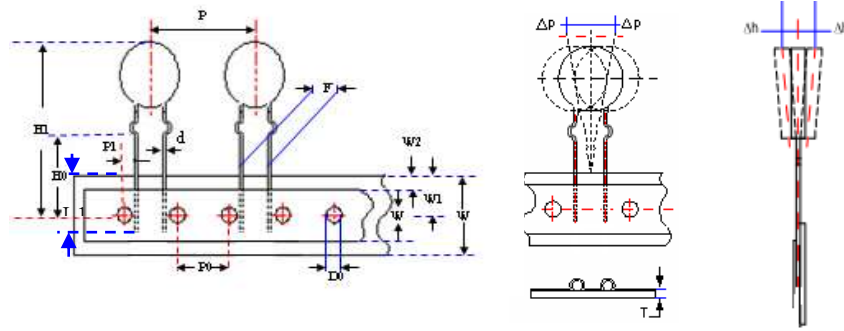
负温度系数热敏电阻器：SCH 系列



高功率型热敏电阻器

F 型(Y 型引脚)

图 A



图 B



(单位: mm)

编带尺寸	本体尺寸	P0	F	P	P1	H	H1	d	W0	W1	W2	W	ΔP	Δh	L1	D0	T	图形
		±0.3	±0.5	±1	±0.7	+2/-0	Max.	±0.02	±1.5	+0.75 /-0.5	Max.	+1/ -0.5	Max.	Max.	Min	±0.2	±0.2	
P0:12.7	20	12.7	7.5	25.4	8.95	16	42	1.0	12	9	3	18	1	2	9	4	0.6	A
	20	12.7	10	25.4	7.70	16	42	1.0	12	9	3	18	1	2	9	4	0.6	A
P0:15.0	20	15.0	7.5	30	3.75	16	42	1.0	12	9	3	18	1	2	9	4	0.6	B
	20	15.0	10	30	10	16	42	1.0	12	9	3	18	1	2	9	4	0.6	A

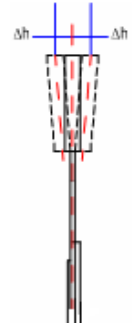
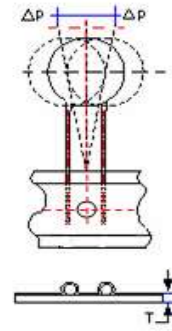
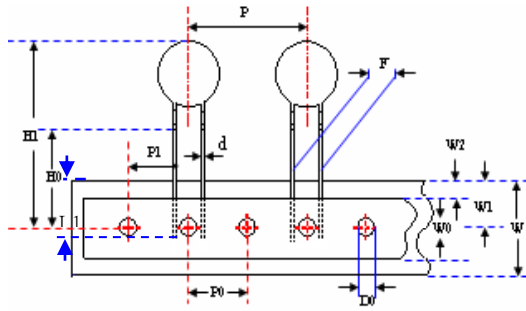
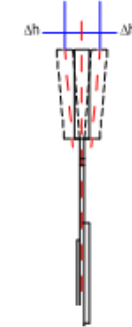
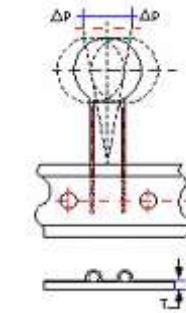
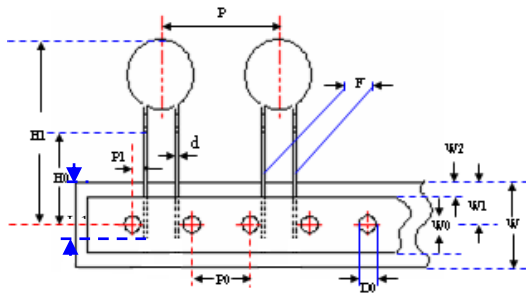
负温度系数热敏电阻器：SCH 系列



高功率型热敏电阻器

■ 包装数量

- 散装：Φ20-90 度弯折品(包含切脚品)包装

尺寸	单包数量	单盒袋数	单盒数	单箱盒数	单箱数	脚型	小白盒尺寸	包装箱尺寸
	(PCS)	(袋)	(pcs)	(盒)	(pcs)		(LxWxH) (单位: mm)	(LxWxH) (单位: mm)
Φ20	50	4	200	16	3200	90度弯折	160*160*65	350*350*290
	50	4	200	16	3200	切脚		

- 盒装

1. 插纸排盒装

包装方式：20pcs/排，30 排/盒，600pcs/盒

内盒尺寸：340*340*62mm

外箱包装方式及规格

每箱盒数	每箱总数	规格(L*W*H)mm
2盒	1200pcs	350*350*140

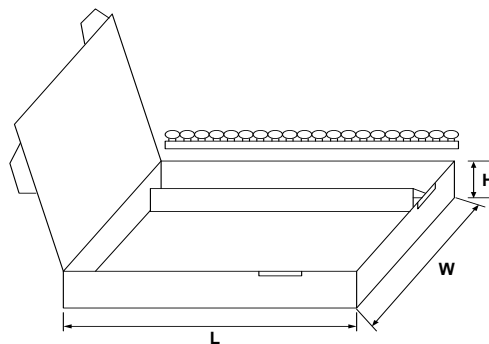

2. 编带盒装

尺寸	单盒数量	包装盒规格尺寸	包装箱规格尺寸	单箱盒数
	(PCS)	(LxWxH)mm	(LxWxH)mm	(盒)
Φ20	400	345*275*55	350*310*290	5

3. 纸板盒装（适用于 Φ25mm 和 Φ30mm 产品）

规格	单板数量 (pcs)	包装板规格尺寸	包装数量
	(PCS)	(L*W*D*I)mm	(盒)
包装板	22	320*155*30*5.7 (25Φ)	330pcs
		320*155*35*5.7 (30Φ)	

负温度系数热敏电阻器：SCH 系列



高功率型热敏电阻器

● 编带卷轴包装

编带轴装

轴装品使用纸管的规格尺寸			
尺寸	D	D1	W
Φ20	340±10mm	31±1mm	55±1mm
注：特殊高度产品可选取合适高度的纸管			

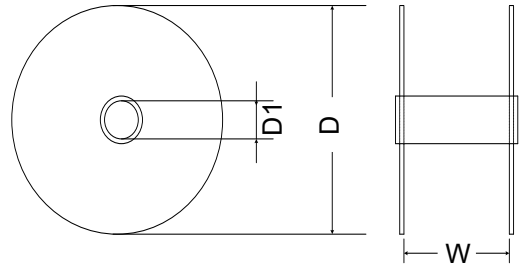

尺寸	轴装数量 (PCS)	包装盒规格尺寸	包装箱规格尺寸	单箱轴数 (轴+外盒)
		(LxWxH)mm	(LxWxH)mm	
Φ20	400	不用内盒	350*350*290	4

■ 仓库存储条件

● 存储条件：

1. 存储温度：-10°C~+40°C
2. 相对湿度：≤75%RH
3. 不要将本产品存放在有腐蚀性气体或是阳光直接照射的环境中保管。

● 存储期限：1年